

# HABERLEŐME VE YÜKLEME KABLO ŐEMALARI

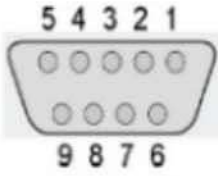

BİRLEŐİK ELEKTRİK ve ELEKTRONİK  
OTOMASYON SAN. TİC. LTD. ŐTİ.



9-Dişi

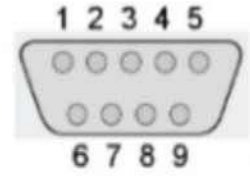
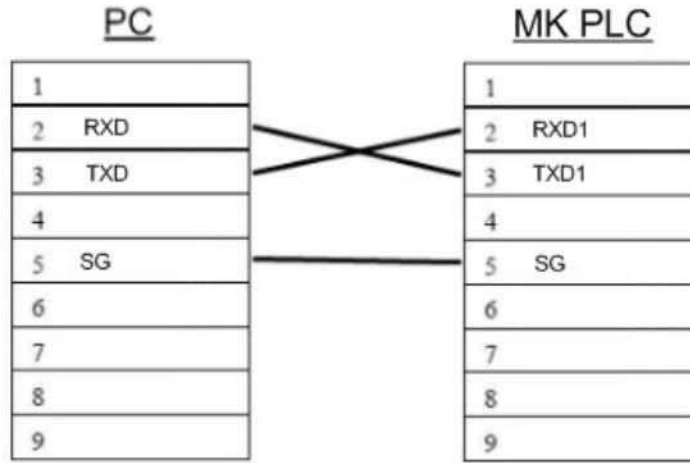

9-Erkek

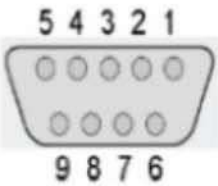

9-Dişi

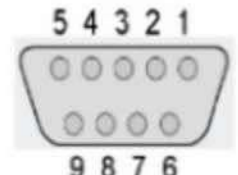
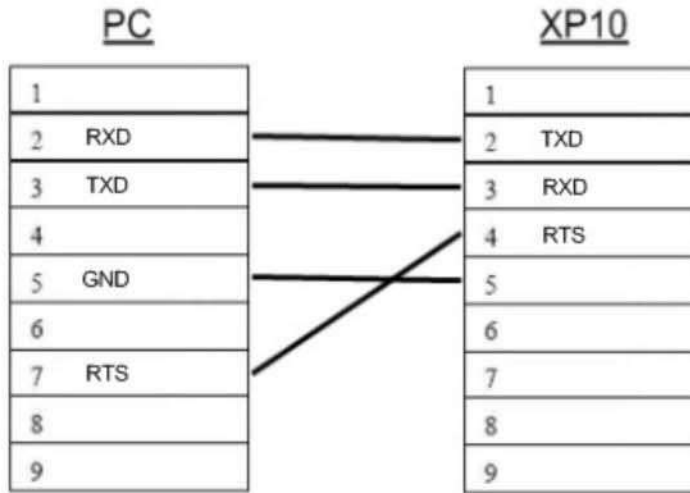

9-Dişi

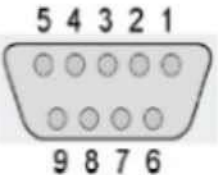

9-Dişi

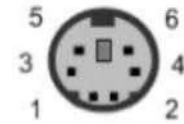
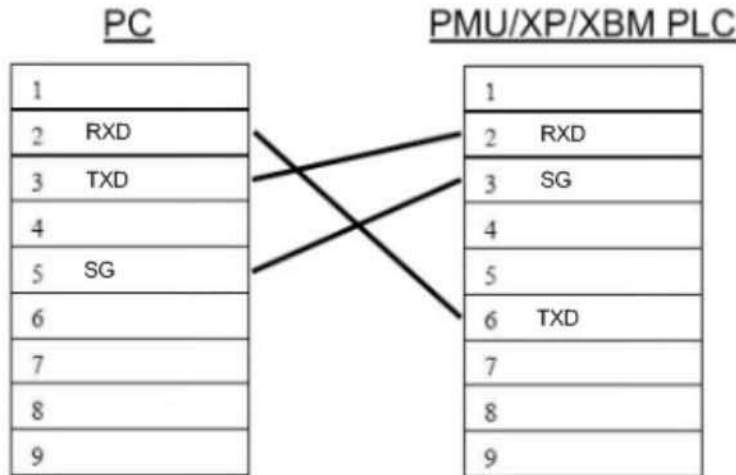
PS/2  
6-pin

**APARAT** (PC-PLC kablosunu PC-PMU/XP/XBM kablosuna dönüştürür)

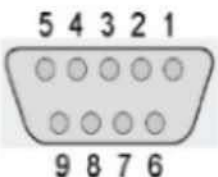

9-Dişi

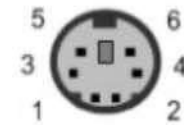
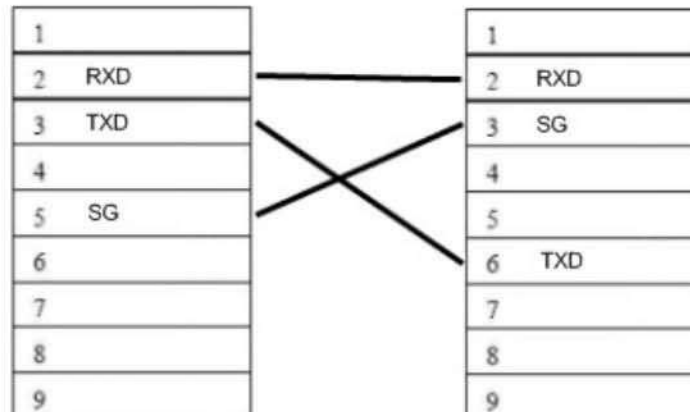
PS/2  
6-pin



**MK PLC (Loader)**

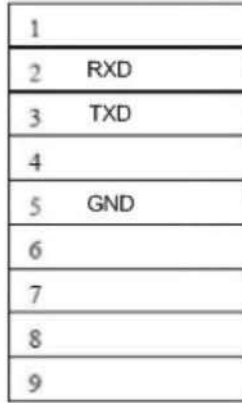

**PMU 330**

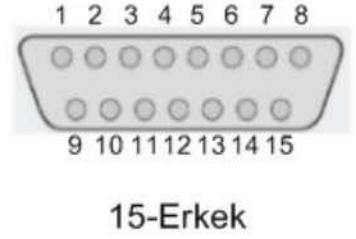
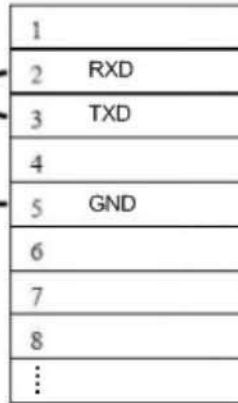

**MK PLC (C-NET)**

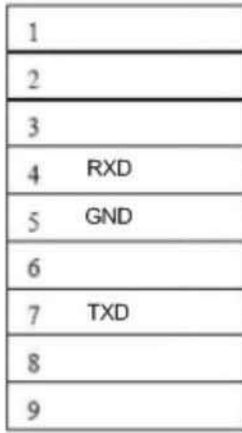
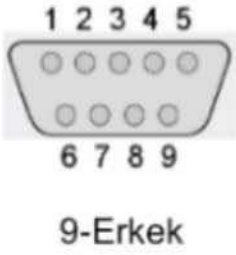

**PMU 330**

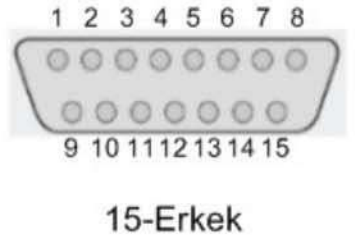
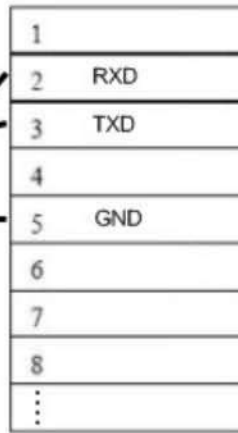

**MK PLC (Loader)**

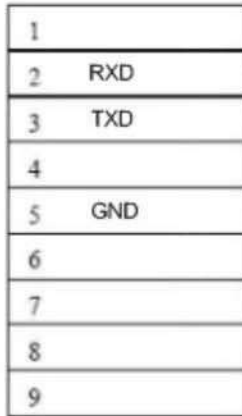
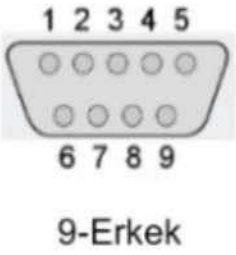

**XP10**

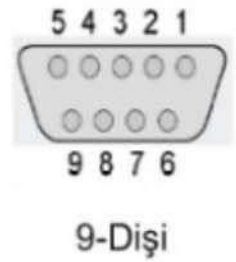
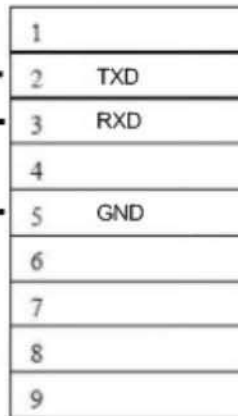

**MK PLC (C-NET)**

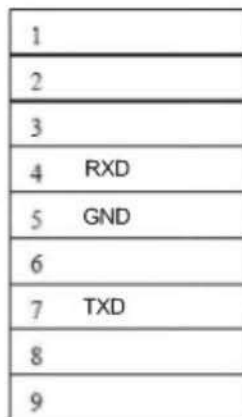
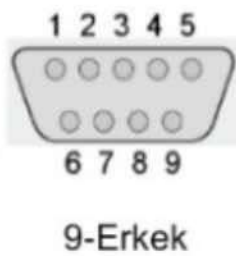

**XP10**

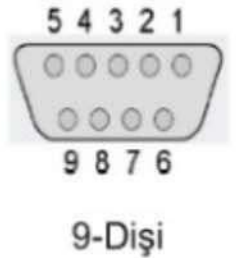
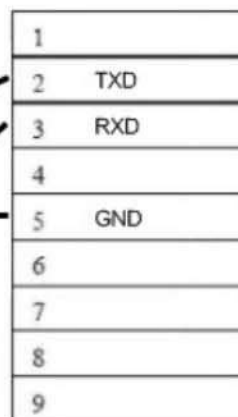

## MK PLC (Loader)

## XP Panel

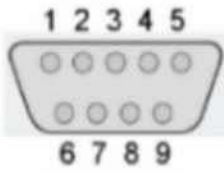

9-Erkek

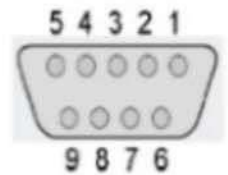
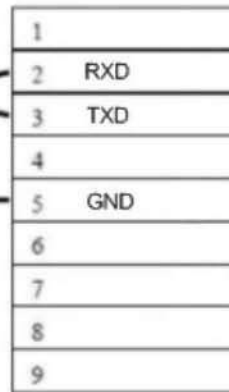
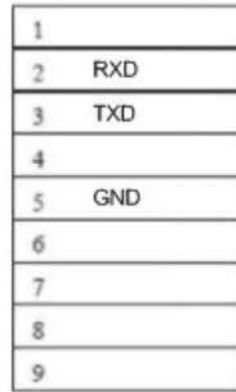

9-Dişi

## MK PLC (C-NET)

## XP Panel

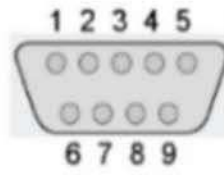

9-Erkek

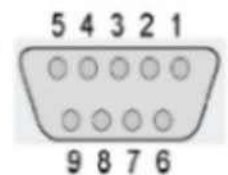
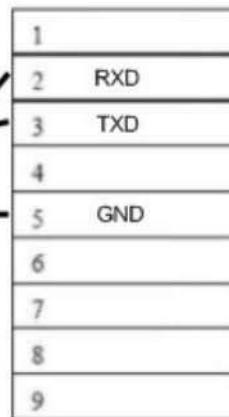
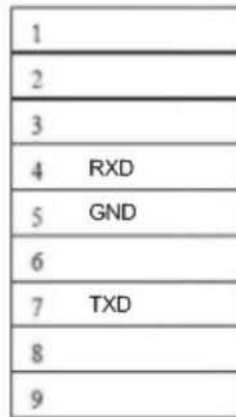

9-Dişi

## PMU 330

## XP Panel

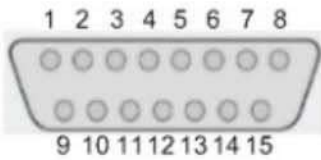

15-Erkek

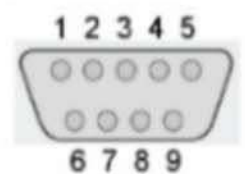
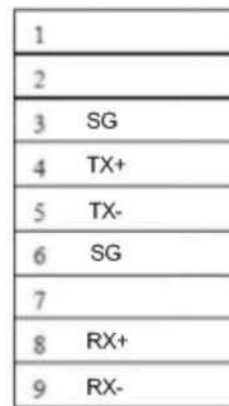
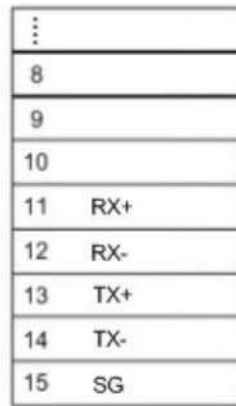

9-Erkek

\* RS485 pin no.

## XP Panel Ekonomik

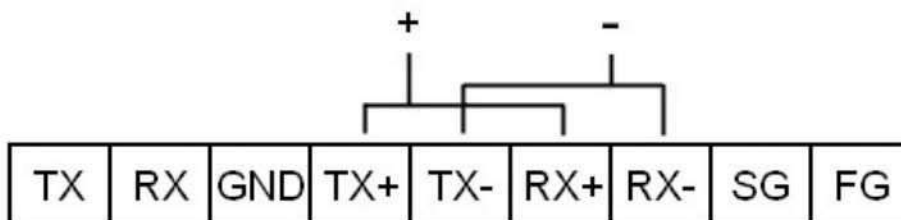

\* RS485 pin no.

\* Panele arkadan bakış

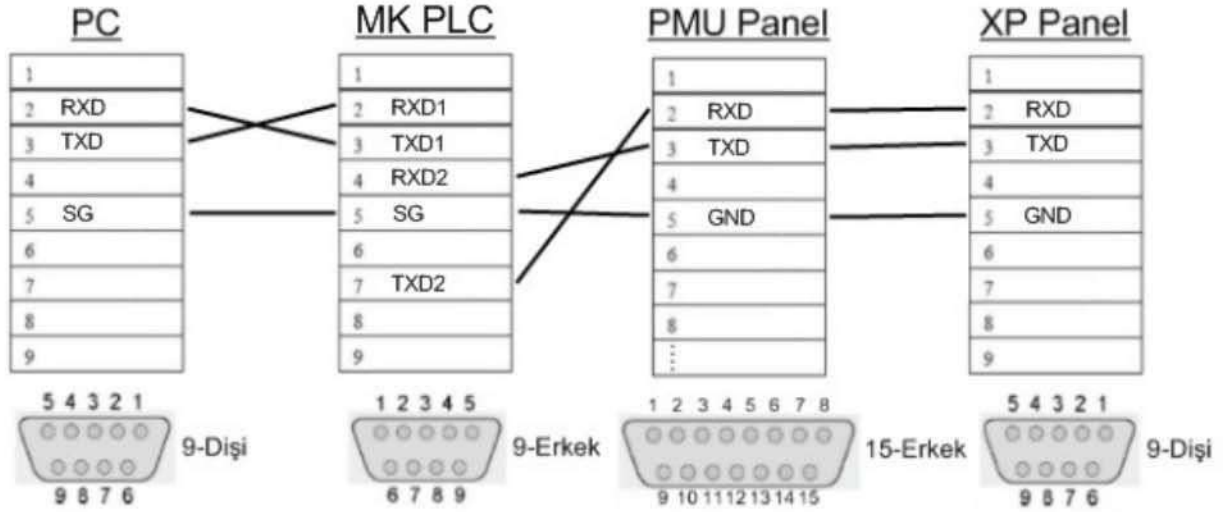

\* 3'lü Haberleşme Kablosu

## PROFIBUS GENEL BAĞLANTI

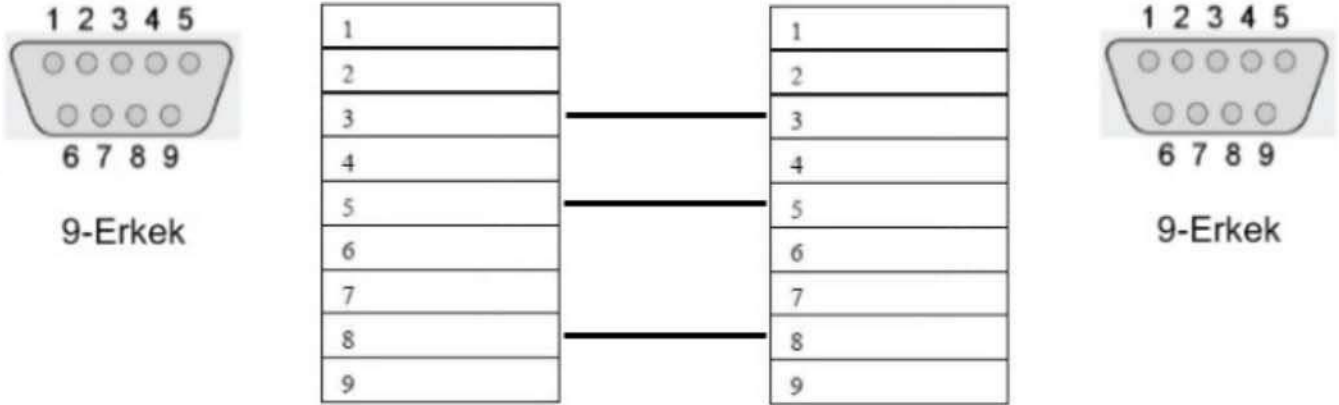

\* Sürüm 1.12

\* Tüm soketler önden (pinli taraftan) bakılarak çizilmiştir.